

GRUPE ELECTROGENE

CENTRALE GAZ COGENERATION

PARTIE COMMUNE 2 GROUPES EN PRODUCTION

ARMOIRE AUTOMATIQUE

Tension Telecommande 24V=

INDICE	DATE	OBJET	PREPARE	VERIFIE	APPROUVE
B	13-06-00	MISE A JOUR	HORNIERE B	BOUYER T.	
A	23-05-00	MISE A JOUR	H. GAUTIER	T. BOUYER	
0	3-04-00	1ere EMISSION	H. GAUTIER	T. BOUYER	
REVIEW		DESCRIPTION	PREPARED BY	CHECKED BY	APPROVED BY

MODIFICATIONS

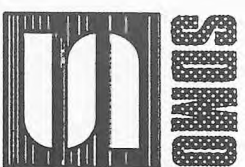

SCHEMA ELECTRIQUE
PLAN DE BORNIEERS
LISTE MATERIEL

SOMMO

GROUPES ELECTROGENES-APPLICATIONS

MOTEURS INDUSTRIELS

12 bis rue de la Villeneuve

29272 BREST Cedex

Tel. 98 41 41 41 - Fax 98 41 41 41 - Telecopie 98 41 63 07

REFERENCE CLIENT
CUSTOMER REFERENCE

Cde : R9952178

OM : 102565

REFERENCE SOREEL



AFFAIRE : 371353.03

CONTRACT : 371353.03

No PLAN : E14264

DRAWING : E14264

ECHELLE :
SCALE :
FORMAT :
SIZE :
A4

ST JACQUES
CLERMONT FERRAND

No FOLIO	01	02	03	04	05	06	07	08	09	10	11	12	13	14	15	16	17	18	19	20	21	22	23	24	25
1																									
2																									
3																									
4																									
5																									
6																									
7																									
8																									
9																									
10																									
11																									
12																									
13																									
14																									
15																									
16																									
17																									
18																									
19																									
20																									
21																									
22																									
23																									
24																									
25																									
26																									
27																									
28																									
29																									
30																									
31																									
32																									
33																									



AFF :371353.03
PL : E14264

LISTE DES FOLIOS

MODIFICATION																									
--------------	--	--	--	--	--	--	--	--	--	--	--	--	--	--	--	--	--	--	--	--	--	--	--	--	--

FOLIO

002

1 2 3 4 5 6 7 8 9 10 11 12 13 14 15 16 17 18 19 20 21 22 23 24 25

SECTEUR

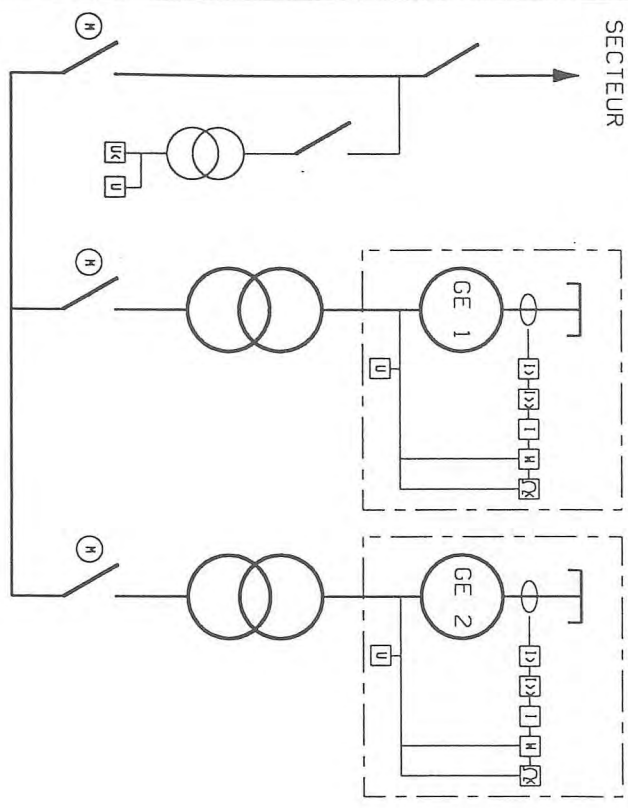

AFF : 371353.03
PL : E14264

UNIFILAIRE DE PRINCIPE

MODIFICATION	

FOLIO
003

01 02 03 04 05 06 07 08 09 10 11 12 13 14 15 16 17 18 19 20 21 22 23 24 25

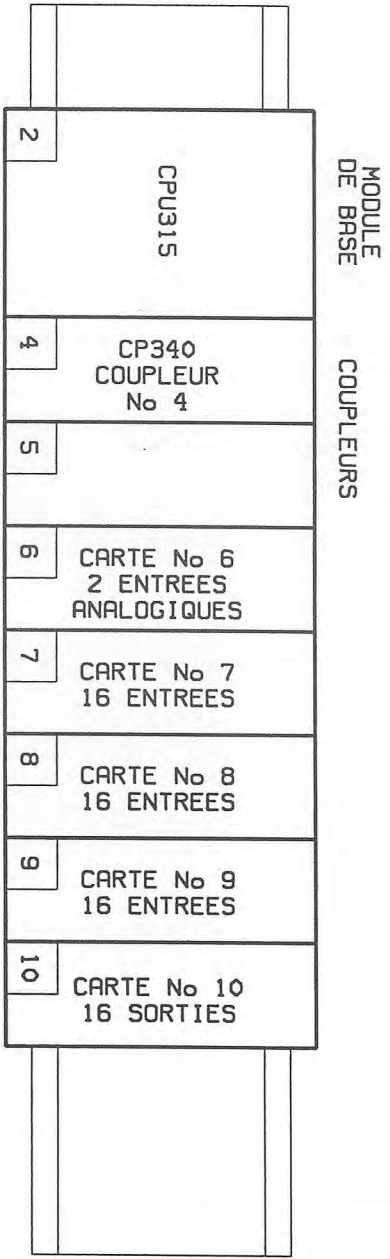

MODULE DE BASE
COUPLEURS

FOLIO 004	MODIFICATION								

IMPLANTATION AUTOMATE

AFF : 371353.03
PL : E14264



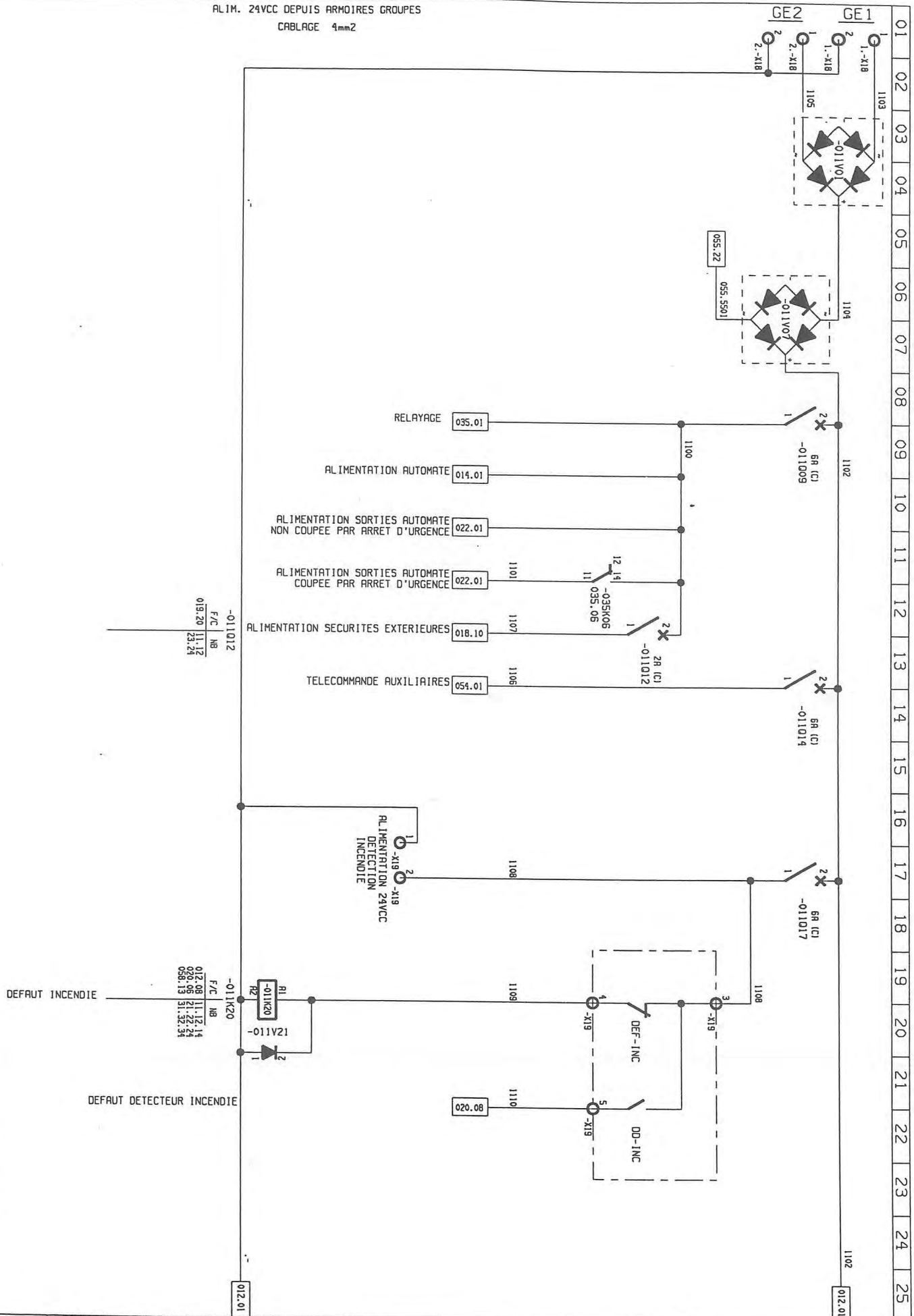

F/C NB
019.20 11.12
23.24

F/C NB
012.08 11.12.14
020.06 21.22.24
058.13 31.32.34

DERNIER NUMERO UTILISE : 1110

FOLIO	MODIFICATION				
011					

PROTECTION CIRCUIT CONTINU COMMUN

AFF : 371353.03
PL : E14264



01 02 03 04 05 06 07 08 09 10 11 12 13 14 15 16 17 18 19 20 21 22 23 24 25

011.25 011.1102 014.01 011.1102

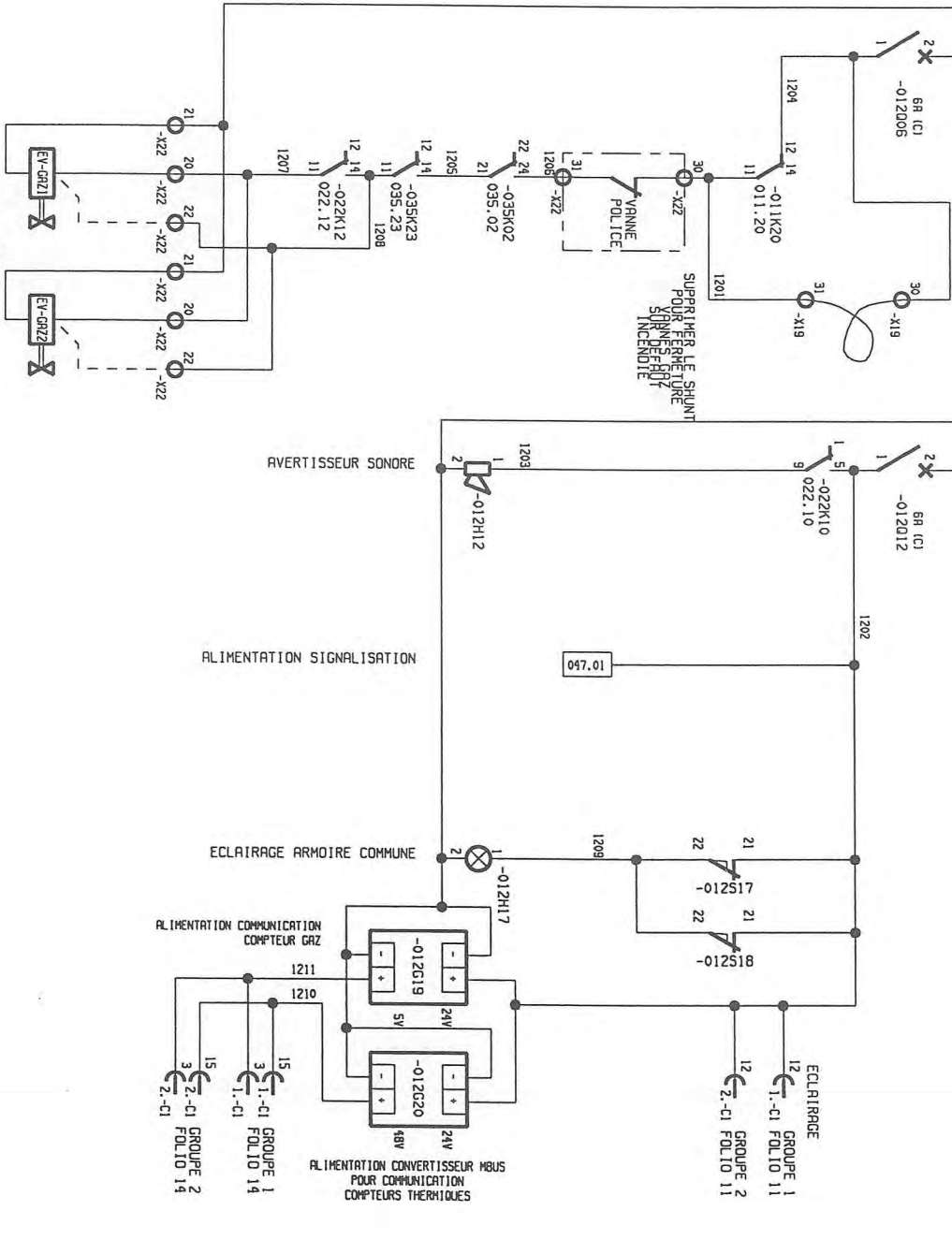

ALIMENTATION
ELECTROVANNES
ISOLEMENT GAZ

AVEC FERMETURE A L'ARRRET
RACCORDEMENT EV BORNE 20

SANS FERMETURE A L'ARRRET
RACCORDEMENT EV BORNE 22

PROTECTION CIRCUIT CONTINU

AFF : 371353.03
PL : E14264



DERNIER NUMERO UTILISE : 1211

MODIFICATION	
FOLIO 012	

01 02 03 04 05 06 07 08 09 10 11 12 13 14 15 16 17 18 19 20 21 22 23 24 25

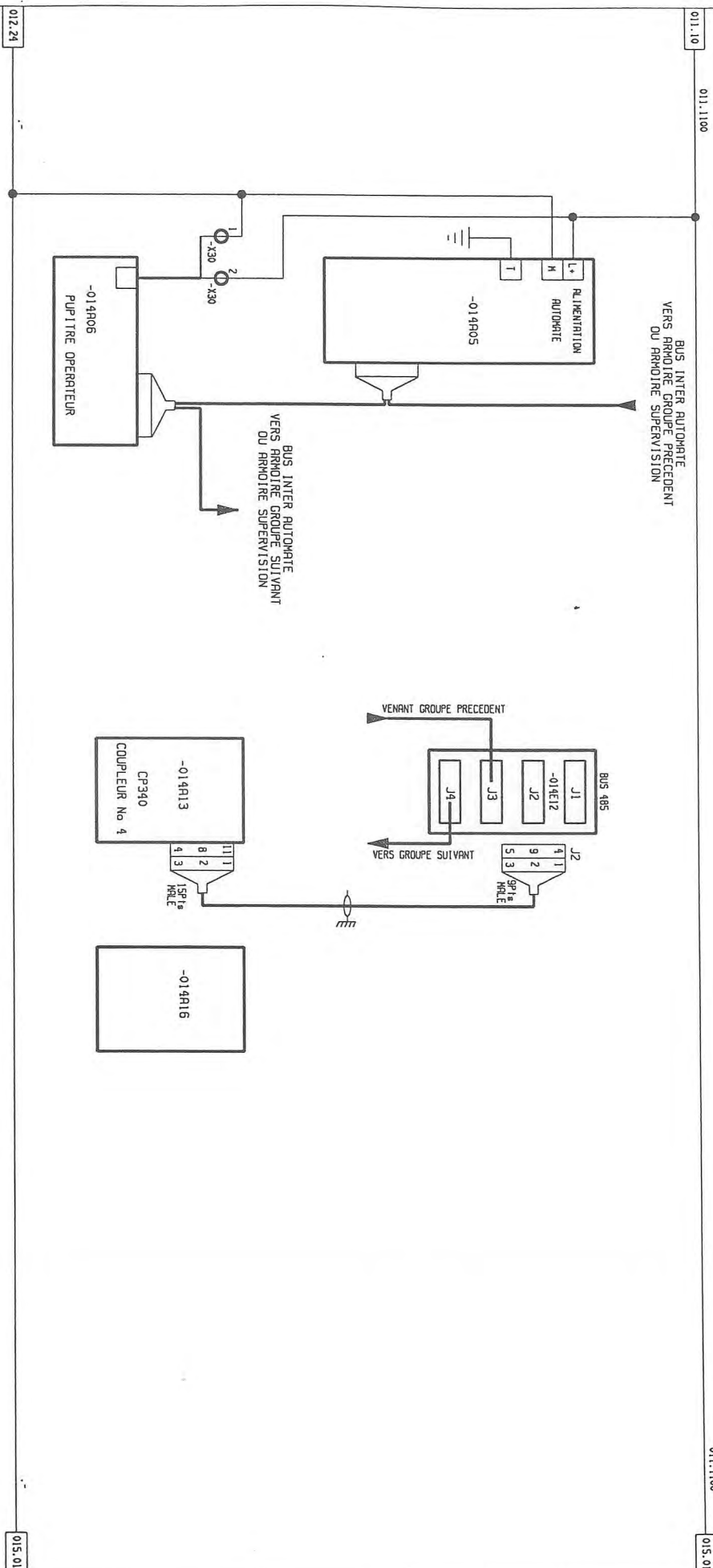

COUPLEUR DE COMMUNICATION
BUS RS485

BOITIER RESERVE

ALIMENTATION AUTOMATE

AFF : 371353.03
PL : E14264



FOLIO 014	MODIFICATION								
	B								

DESIGNER NUMBER UTILISE : 1403

01 02 03 04 05 06 07 08 09 10 11 12 13 14 15 16 17 18 19 20 21 22 23 24 25

014,25 014,23 011,100 011,100 01E,01 01E,01 016,01

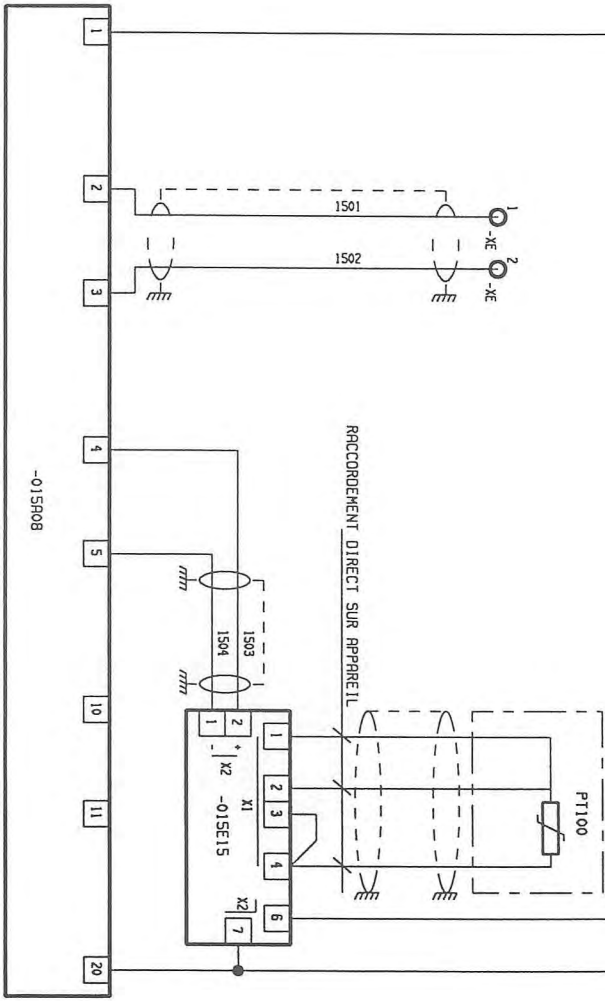

TEMPERATURE LOCAL GROUPE

RACCORDEMENT DIRECT SUR APPAREIL

-015RA08

AFF : 371353.03
PL : E14264



ENTREES ANALOGIQUES CARTE No 6

MODIFICATION

FOLIO 015

DERNIER NUMERO UTILISE : 1507

01 02 03 04 05 06 07 08 09 10 11 12 13 14 15 16 17 18 19 20 21 22 23 24 25

011.1100

011.1100



AFF : 371353.03
PL : E14264

ENTREES CARTE No 7

DESIGNATION	ADRESSE
PRESENCE TENSION SECTEUR	E12.0
DEFAUT TT AMONT CELLULE GENERALE	E12.1
DEFAUT BLOC AUTONOME 48VCC CELLULE HT CENTRALE	E12.2
CELLULE GENERALE OUVERTE	E12.3
CELLULE GENERALE FERMEE	E12.4
DECLENCHEMENT CELLULE GENERALE	E12.5
CELLULE INTER ISOLEMENT FERMEE	E12.6
DEFAUT GTE	E12.7

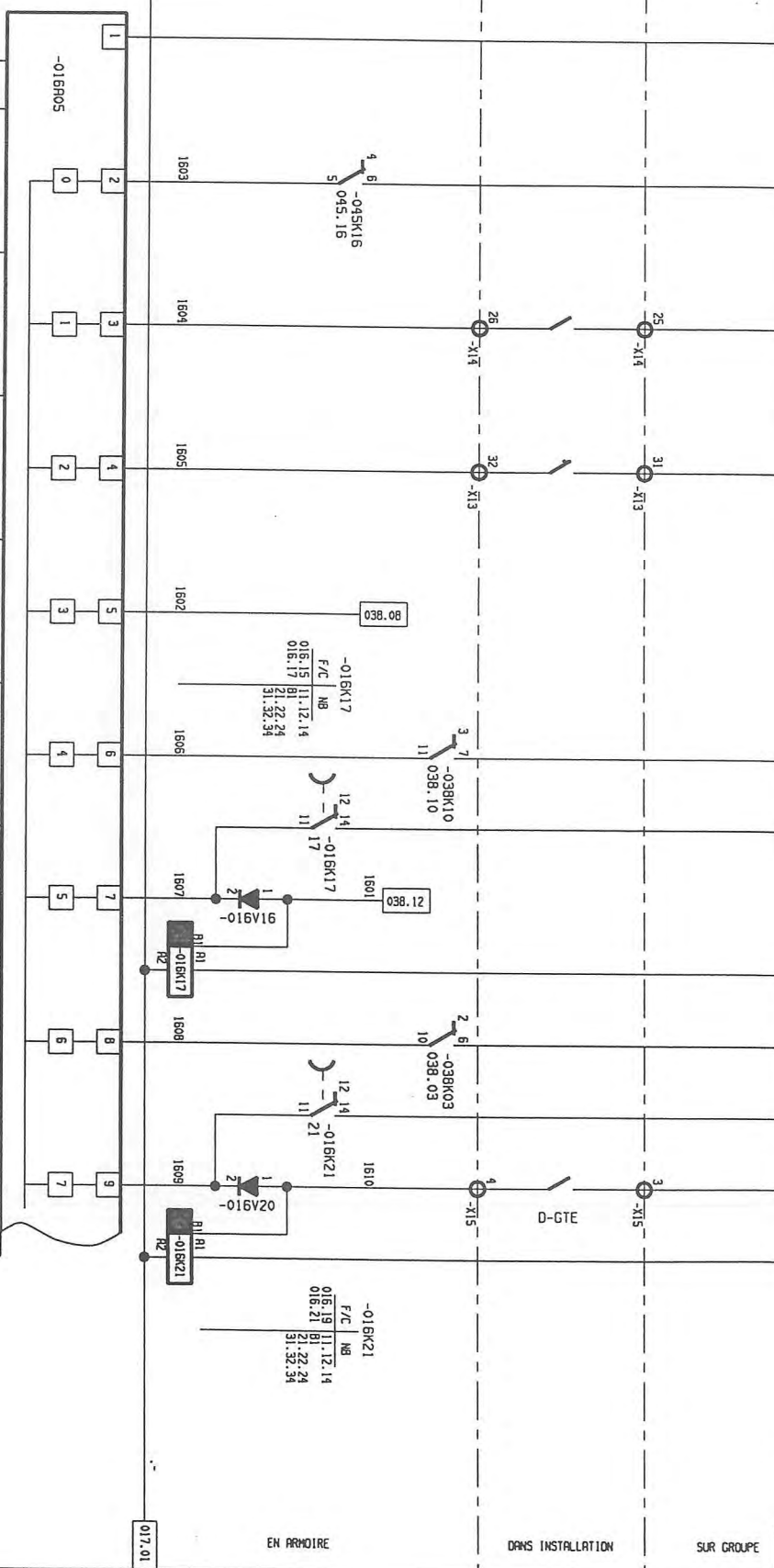

DERNIER NUMERO UTILISE : 1610

FOLIO	MODIFICATION
016	

01 02 03 04 05 06 07 08 09 10 11 12 13 14 15 16 17 18 19 20 21 22 23 24 25

016.23 011.1100

018.01 011.1100

SUR GROUPE

DANS INSTALLATION

EN ARMOIRE

DESIGNATION	ADRESSE
DEFAULT POMPE AERO EQUILIBRE	E13.0
NIVEAU BAS EAU AERO EQUILIBRE	E13.1
	E13.2
ESSAI EN CHARGE	E13.3
DEMANDE PRODUCTION	E13.4
MODE AUTO	E13.5
BP OUVERTURE CELLULE GENERALE	E13.6
BP FERMETURE CELLULE GENERALE	E13.7

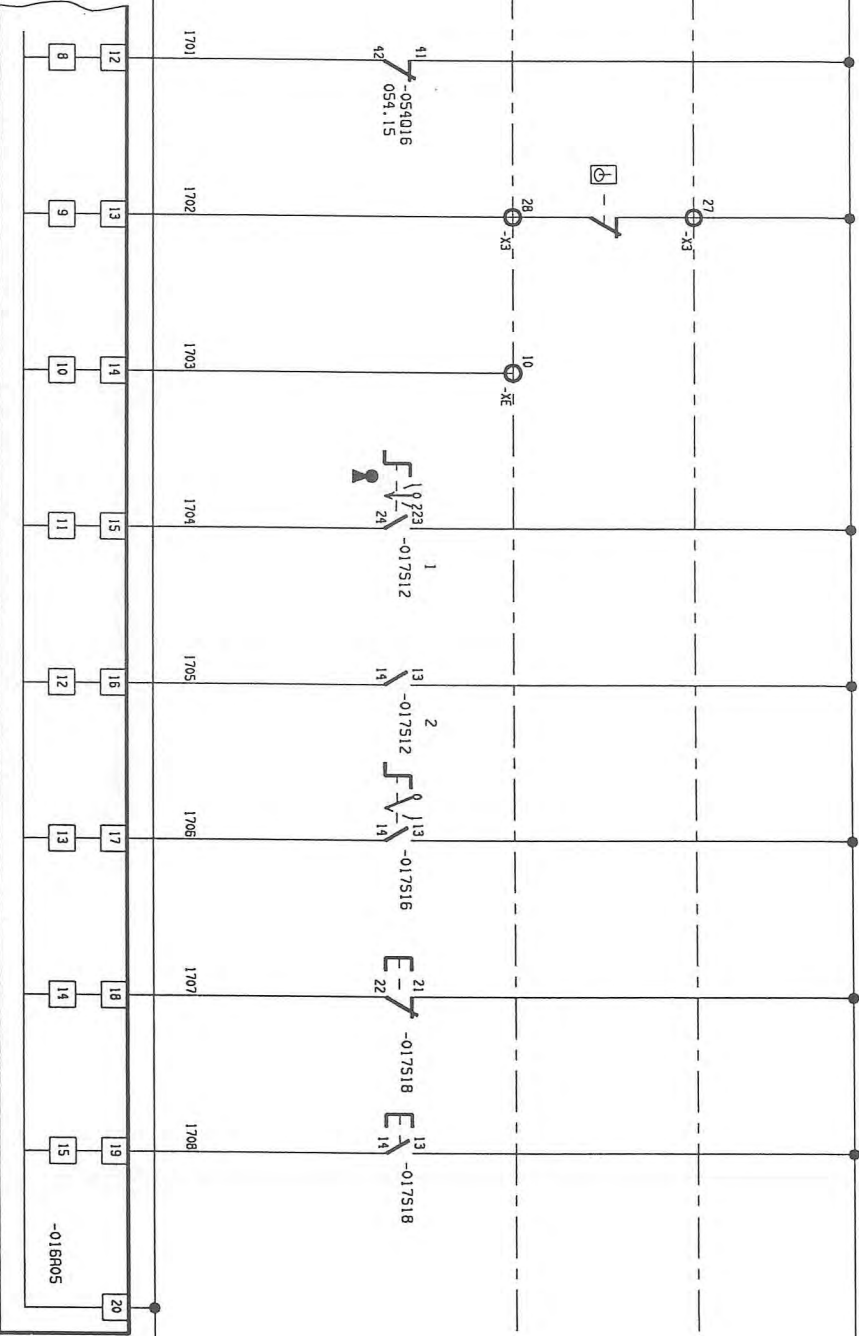

DERNIER NUMERO UTILISE : 1708

FOLIO	MODIFICATION				
	A	B			
017					

ENTREES CARTE No 7

AFF : 371353.03
PL : E14264



01 02 03 04 05 06 07 08 09 10 11 12 13 14 15 16 17 18 19 20 21 22 23 24 25

DESIGNATION	ADRESSE
	E16.0
	E16.1
OPERATEUR PRESENT	E16.2
THERMOSTAT LOCAL GROUPE GAZ	E16.3
DEFAULT ET MINI TENSION BATTERIE DE TELECOMMANDE	E16.4
ARRET D'URGENCE CENTRALE	E16.5
DEFAULT MINI PRESSION GAZ No1	E16.6
DEFAULT MINI PRESSION GAZ No2	E16.7

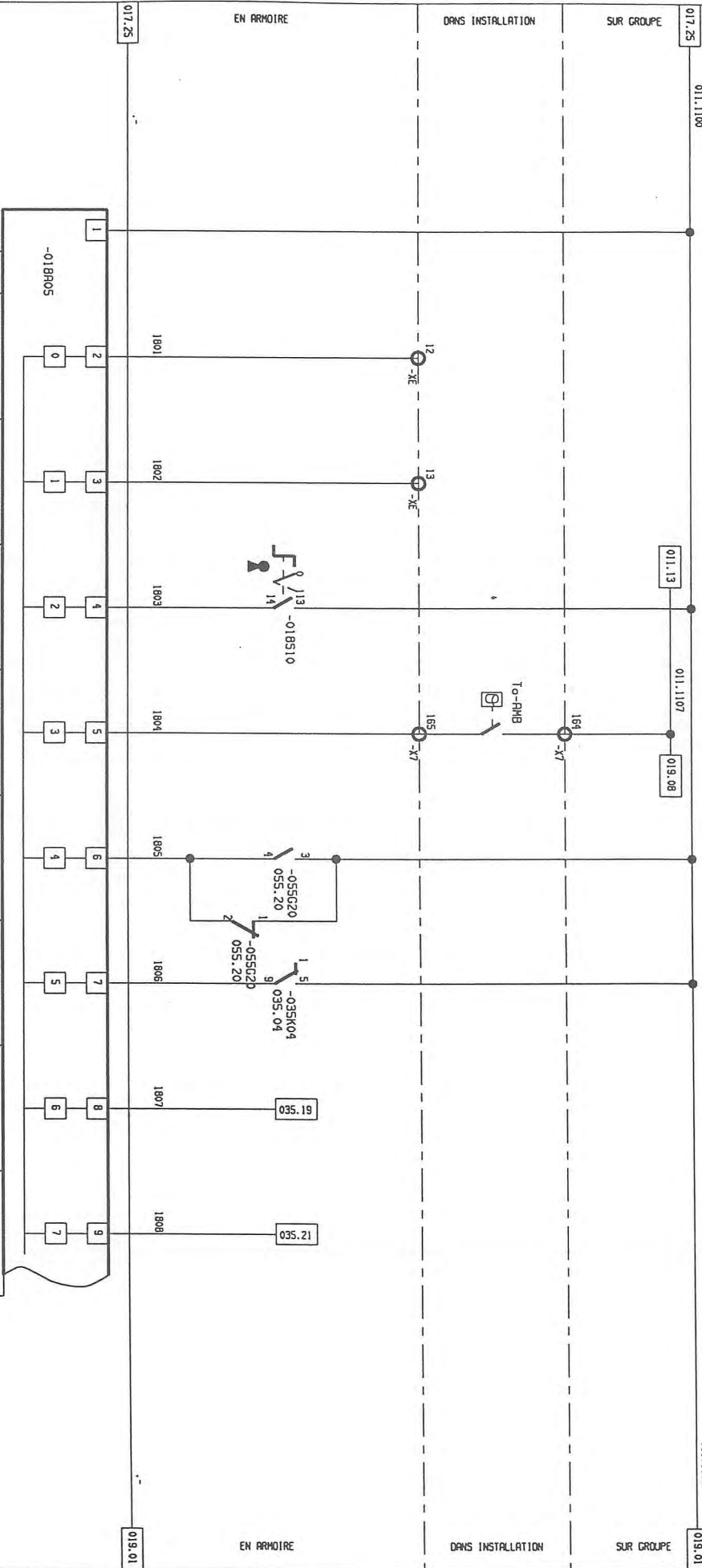

DERNIER NUMERO UTILISE : 1808

FOLIO	MODIFICATION

ENTREES CARTE No 8

AFF:371353.03
PL : E14264



01 02 03 04 05 06 07 08 09 10 11 12 13 14 15 16 17 18 19 20 21 22 23 24 25

018.25 011.1100 018.13 011.1107 020.10 011.1100 020.01

SUR GROUPE

DANS INSTALLATION

EN ARMOIRE

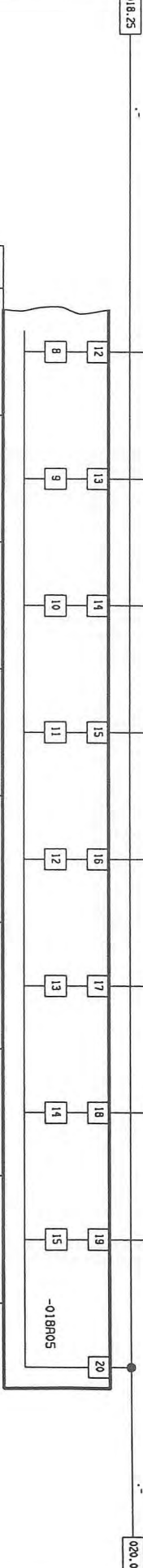

DESIGNATION	ADRESSE
	E17.0
ELECTROVANNE GENERALE DE GAZ FERMEE	E17.1
NIVEAU HAUT BACHE HUILE USEE	E17.2
NIVEAU BAS BACHE HUILE NEUVE	E17.3
DEFAULT POMPE HUILE NEUVE	E17.4
DEFAULT POMPE TRAITEMENT EAU AERO	E17.5
DEFAULT POMPE TRAITEMENT EAU MOTEUR	E17.6
DECLENCHEMENT PROTECTION SECURITES EXTERIEURES	E17.7

DERNIER NUMERO UTILISE : 1908

FOLIO	MODIFICATION

ENTREES CARTE No 8

AFF :371353.03

PL : E14264



01 02 03 04 05 06 07 08 09 10 11 12 13 14 15 16 17 18 19 20 21 22 23 24 25

019.23 011.1100 019.13 021.06 011.1107 021.01 011.1100

SUR GROUPE

DANS INSTALLATION

EN ARMOIRE

SUR GROUPE

DANS INSTALLATION

EN ARMOIRE

DESIGNATION	ADRESSE
DEFAUT INCENDIE	E20.0
DEFAUT DETECTEUR INCENDIE	E20.1
	E20.2
	E20.3
	E20.4
	E20.5
	E20.6
	E20.7

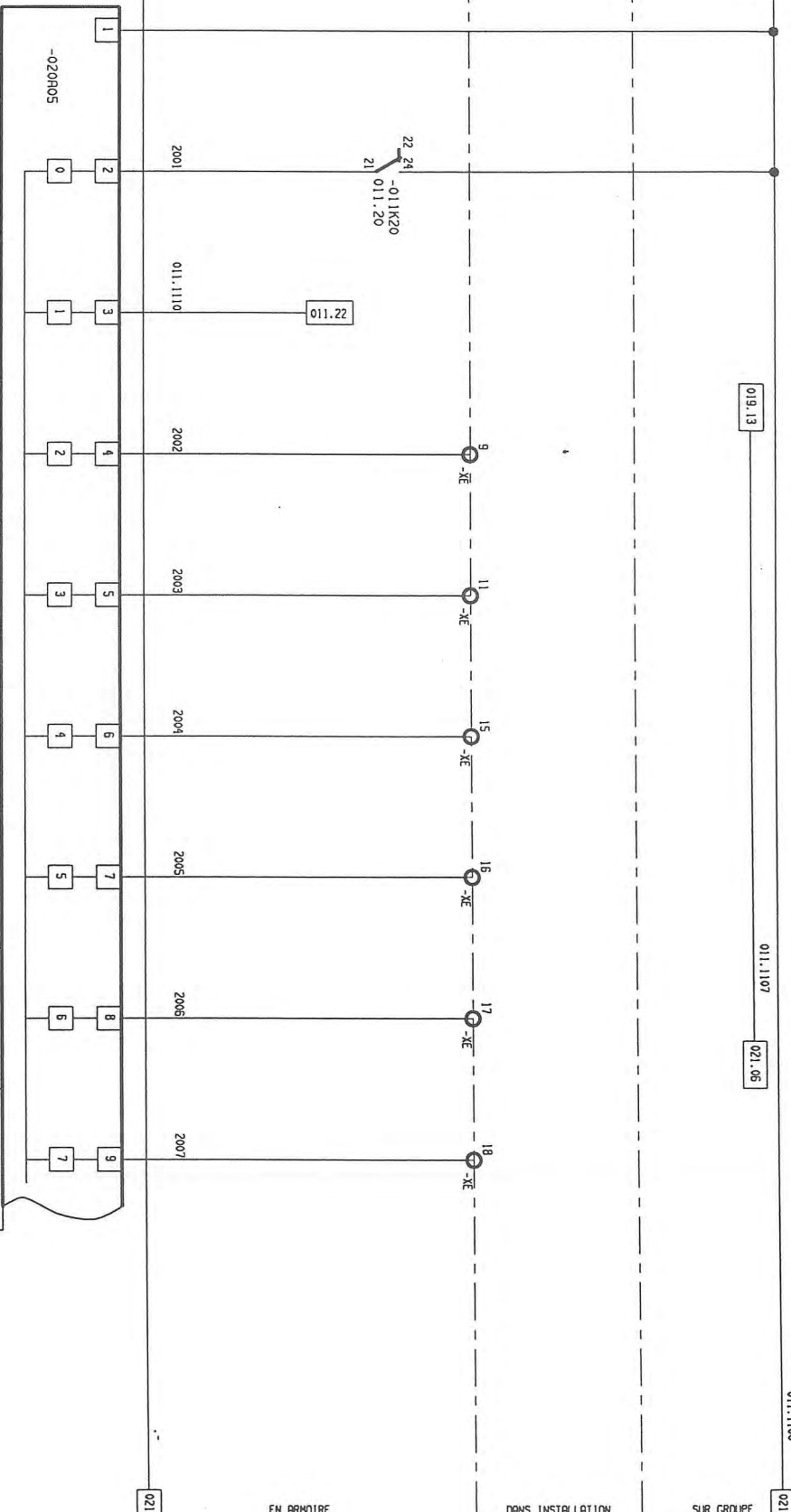

ENTREES CARTE No 9

AFF : 371353.03
PL : E14264



MODIFICATION	
B	

FOLIO

020

DERNIER NUMERO UTILISE : 2007

01 02 03 04 05 06 07 08 09 10 11 12 13 14 15 16 17 18 19 20 21 22 23 24 25

020.25 011.100

020.19

011.107

011.100
011.107



SUR GROUPE

DANS INSTALLATION

EN ARMOIRE

SUR GROUPE

DANS INSTALLATION

EN ARMOIRE

DESIGNATION	ADRESSE
	E21.0
DEFAULT COMMUNICATION AVEC POSTE SOURCE	E21.1
POSTE SOURCE FERME	E21.2
DEFAULT VENTILATEUR DESENFUMAGE	E21.3
DEFAULT VENTILATEUR PERMANENT	E21.4
	E21.5
	E21.6
	E21.7

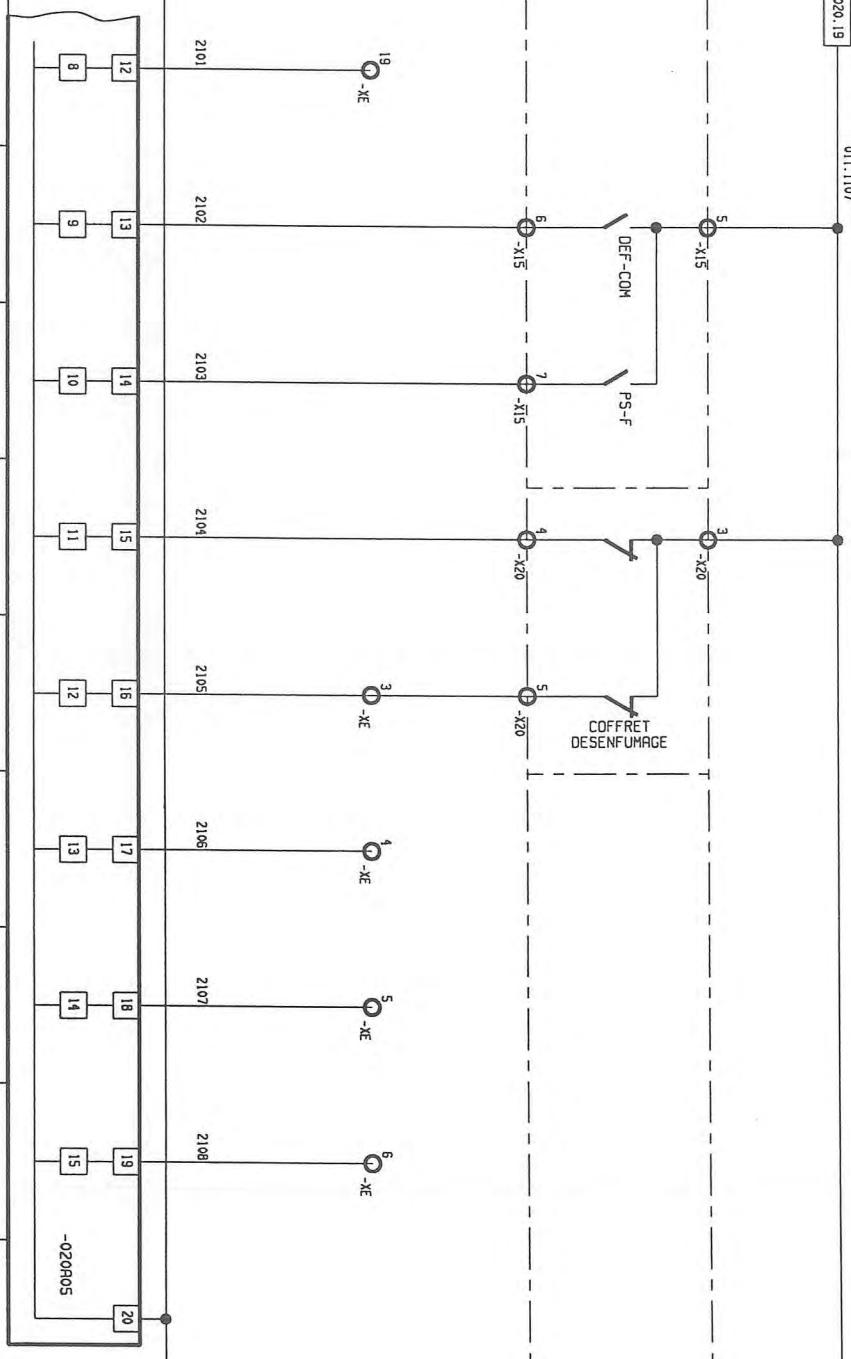

DERNIER NUMERO UTILISE : 2108

FOLIO	MODIFICATION
021	

ENTREES CARTE No 9

AFF : 371353.03
PL : E14264

01 02 03 04 05 06 07 08 09 10 11 12 13 14 15 16 17 18 19 20 21 22 23 24 25

ADRESSE	DESIGNATION
A24.0	CHIEN DE GARDE
A24.1	APPEL TELESURVEILLANCE SUR DEFRAUT (A MANQUE)
A24.2	COMMANDE AVERTISSEUR SONORE
A24.3	COMMANDE OUVERTURE ELECTROVANNE GENERALE DE GAZ
A24.4	MISE HORS SERVICE GROUPES
A24.5	DEMANDE PRODUCTION
A24.6	
A24.7	COMMANDE VENTILATEUR DESENFUMAGE

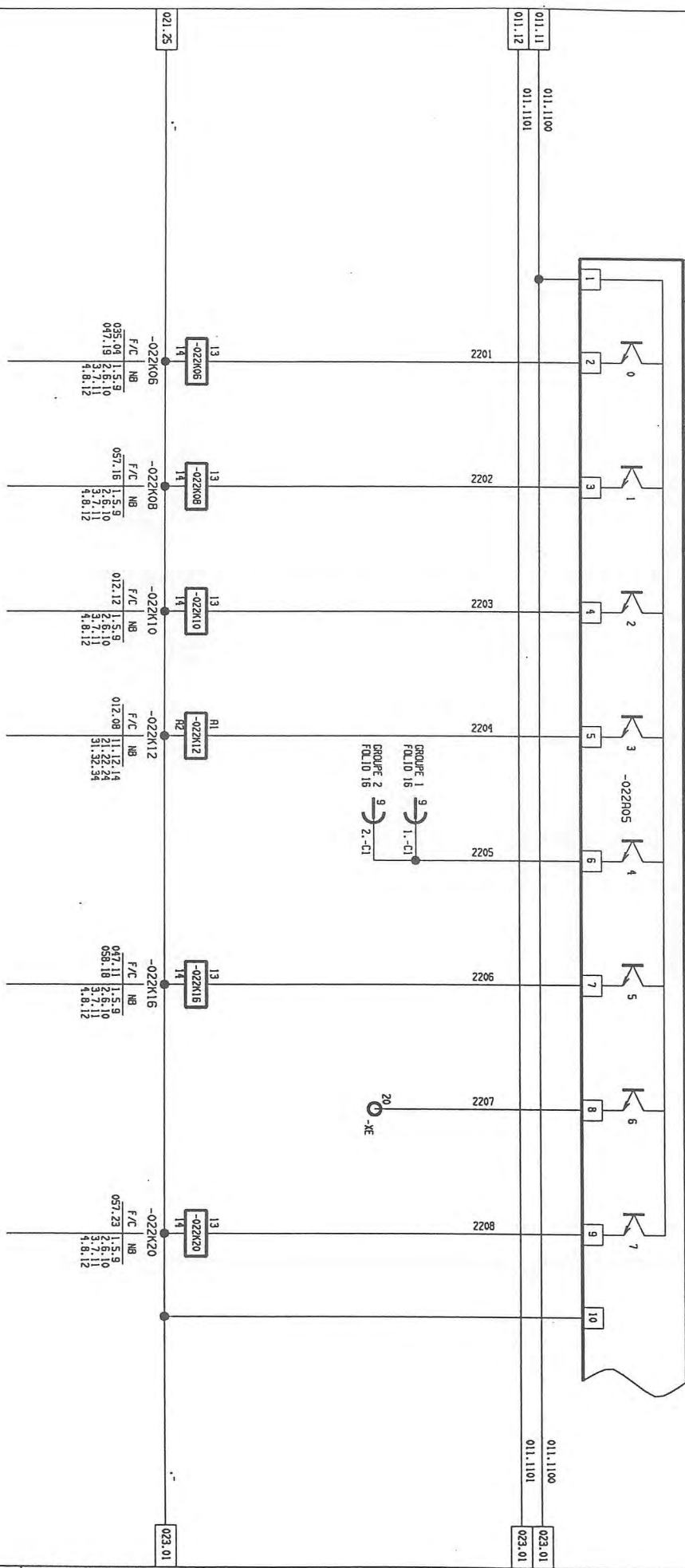

021.25
011.11
011.12
011.100
011.101
023.01
023.01
023.01

AFF : 371353.03	PL : E14264	

MODIFICATION

--	--	--	--	--	--	--	--	--	--

FOLIO 022

DERNIER NUMERO UTILISE : 2208

01 02 03 04 05 06 07 08 09 10 11 12 13 14 15 16 17 18 19 20 21 22 23 24 25

ADRESSE	DESIGNATION
A25.0	CENTRALE DISPONIBLE EN AUTO
A25.1	COMMANDE OUVERTURE CELLULE GENERALE
A25.2	COMMANDE FERMETURE CELLULE GENERALE
A25.3	DEFAULT GENERAL
A25.4	COMMANDE POMPE EQUILIBRE
A25.5	
A25.6	
A25.7	

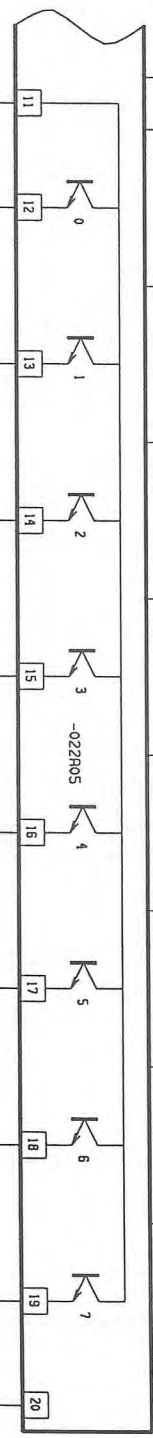

022.25 011.1100
022.25 011.1101
011.1100
011.1101

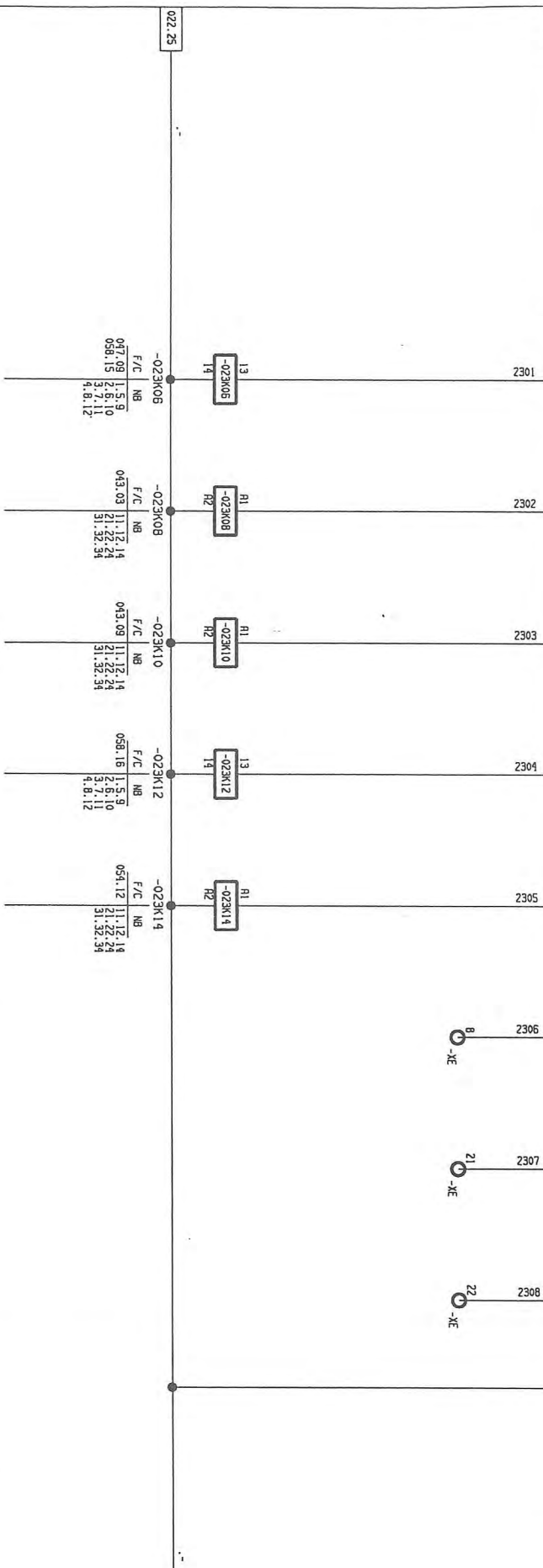

022.25
-023K06
F/C NB
087.09 1.5.9
088.13 3.7.11
9.8.12

-023K08
F/C NB
013.03 11.12.14
31.32.34

-023K10
F/C NB
013.03 11.12.14
31.32.34

-023K12
F/C NB
088.18 1.5.9
3.7.11
9.8.12

-023K14
F/C NB
054.12 11.12.14
31.32.34

SORTIES CARTE No 10

AFF : 371353.03
PL : E14264



DERNIER NUMERO UTILISE : 2308

FOLIO	MODIFICATION
	B
023	

01 02 03 04 05 06 07 08 09 10 11 12 13 14 15 16 17 18 19 20 21 22 23 24 25

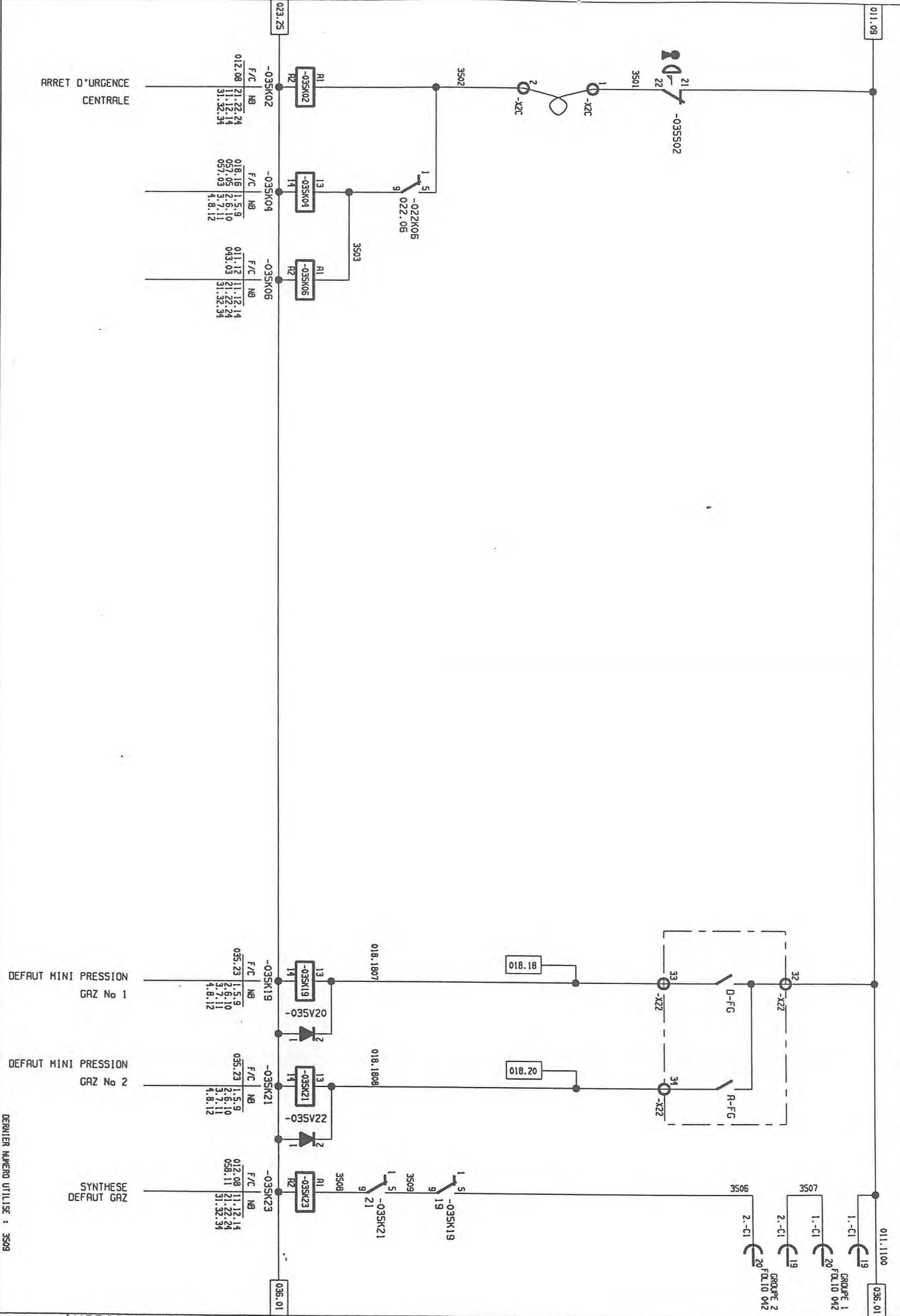

ARRET D'URGENCE CENTRALE

DEFAULT MINI PRESSION GAZ No 1

DEFAULT MINI PRESSION GAZ No 2

SYNTHESE DEFAULT GAZ

DERNIER NUMERO UTILISE : 3509

MODIFICATION									
FOLIO									
035									

RELAYAGE

AFF : 371353.03

PL : E14264



035.25

011.1100

011.1100

038.01



AFF : 371353.03
PL : E14264

RELAYAGE INFO GROUPES

035.25

038.01

GRUPE 1
FOLIO 17

GRUPE 2
FOLIO 17

GRUPE 1
FOLIO 35

GRUPE 2
FOLIO 35



3603

3604

3601

3602

048.03 1.5.9 038.14 1.5.9
2.6.10 048.05 2.6.10
3.7.11 3.7.11
4.8.12 4.8.12

048.07 1.5.9 038.14 1.5.9
2.6.10 048.09 2.6.10
3.7.11 3.7.11
4.8.12 4.8.12

-038K03

-038K05

-038K09

-038K10

F/C NB

F/C NB

F/C NB

F/C NB

TENSION GROUPE 1

CELLULE HT GROUPE 1
FERMEE

TENSION GROUPE 2

CELLULE HT GROUPE 2
FERMEE

FOLIO	MODIFICATION
036	

01 02 03 04 05 06 07 08 09 10 11 12 13 14 15 16 17 18 19 20 21 22 23 24 25

011.1100

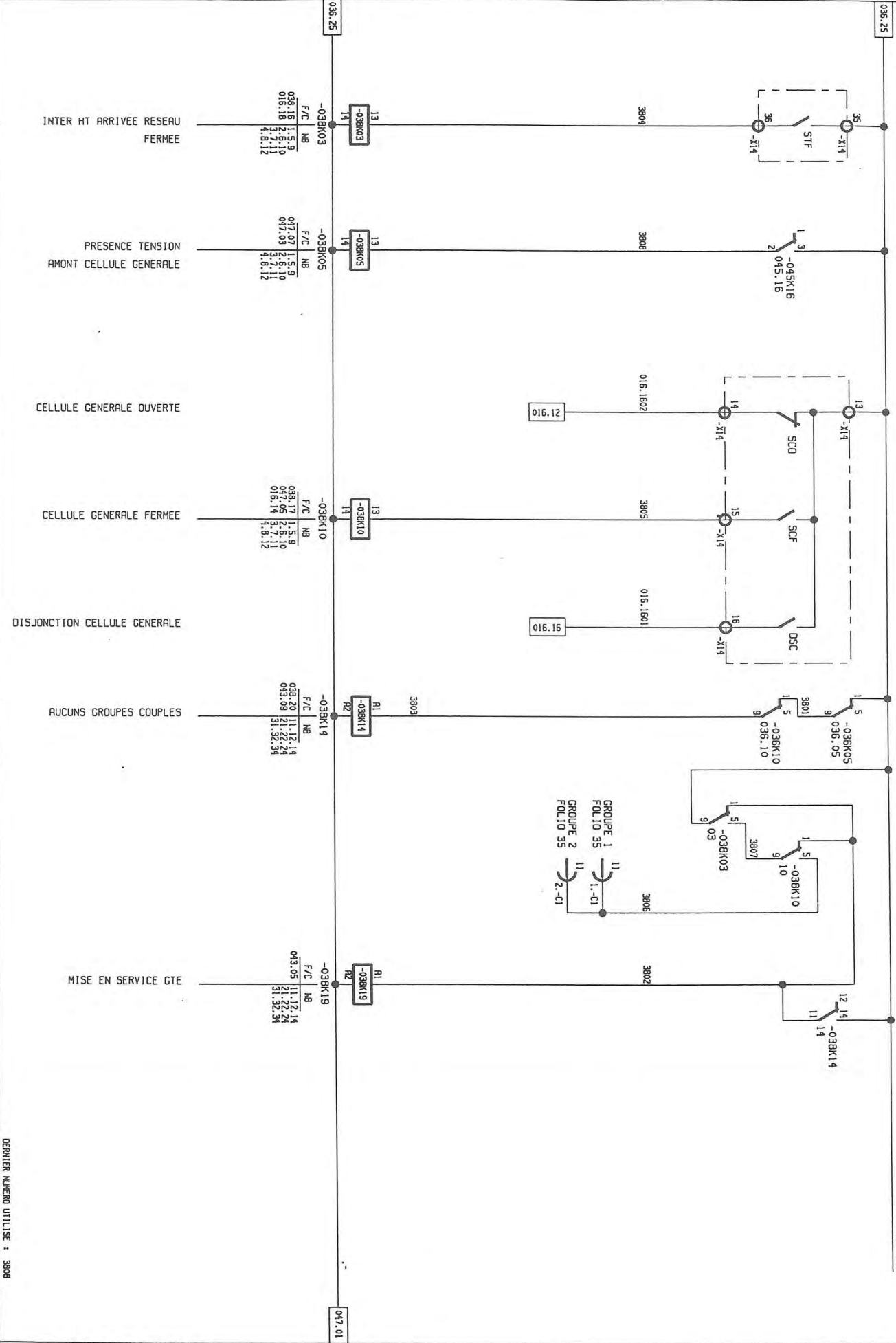

DERNIER NUMERO UTILISE : 3808

038	FOLIO	MODIFICATION

RELAYAGE

AFF : 371353.03
PL : E14264



01 02 03 04 05 06 07 08 09 10 11 12 13 14 15 16 17 18 19 20 21 22 23 24 25

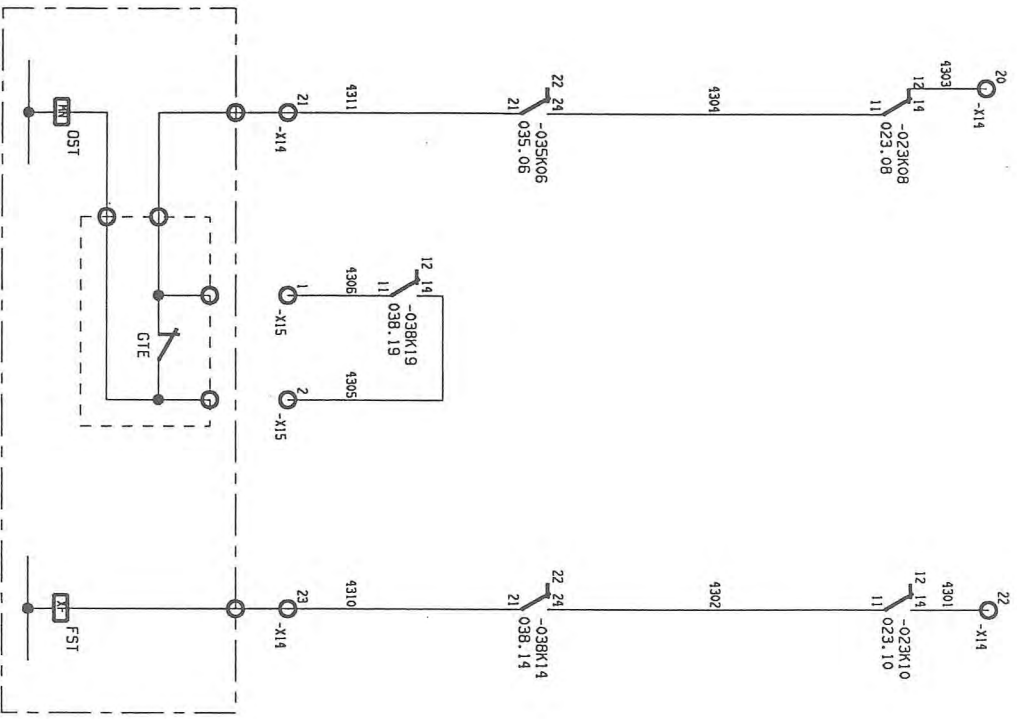

OUVERTURE CELLULE GENERALE

FERMETURE CELLULE GENERALE



AFF : 371353.03
 PL : E14264

COMMANDE CELLULE GENERALE

MODIFICATION	

FOLIO
 043

DERNIER NUMERO UTILISE : 4311

01 02 03 04 05 06 07 08 09 10 11 12 13 14 15 16 17 18 19 20 21 22 23 24 25

BOITIER ESSAIEE TENSION

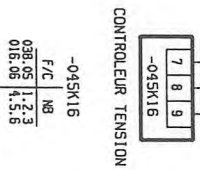
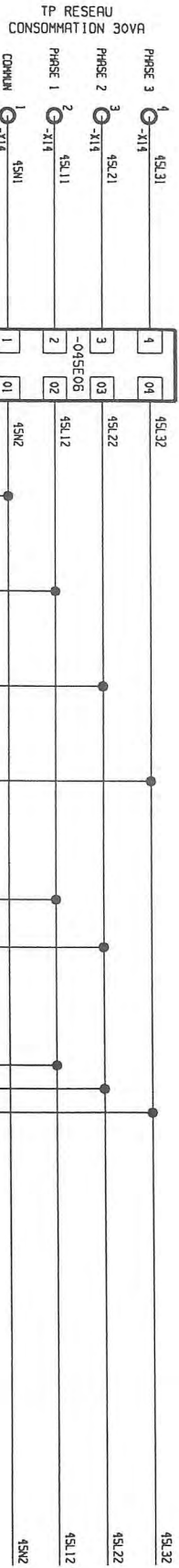

TENSION REMISE EN PHASE
POUR SYNCHRO COUPLAGE

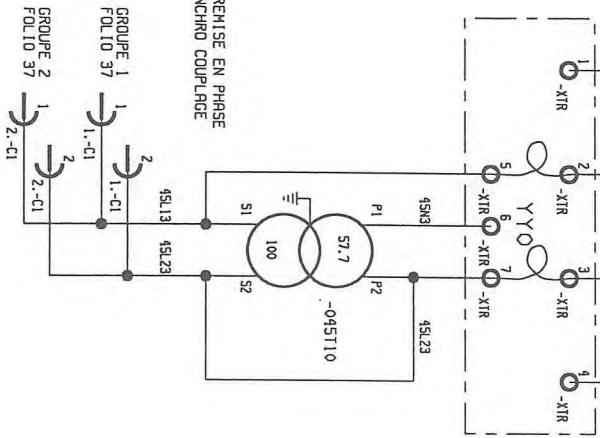

TENSION POUR
EGRILLISATION DE TENSION

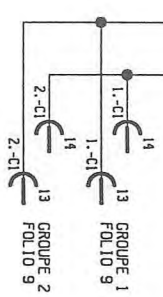

CONTROLE TENSION RESEAU

AFF : 371353.03
PL : E14264



MODIFICATION					

FOLIO

045

01 02 03 04 05 06 07 08 09 10 11 12 13 14 15 16 17 18 19 20 21 22 23 24 25

012.15 012.1202 012.1202 048.01

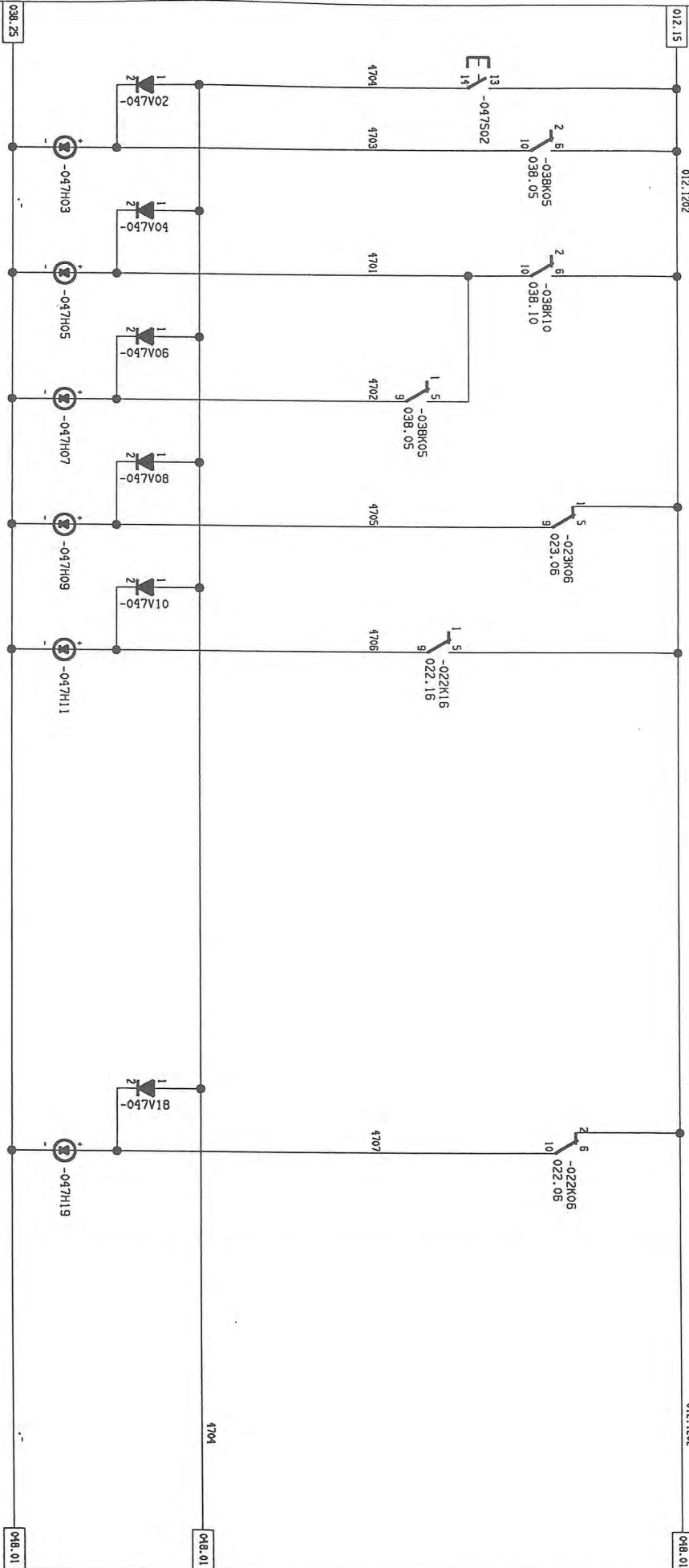

PRESENCE TENSION SECTEUR AMONT CELLULE GENERALE
 CELLULE GENERALE FERMEE
 PRESENCE TENSION JOB SECOURS
 CENTRALE INDISPONIBLE EN AUTO
 PRODUCTION
 DEFAUT AUTOMATE COMMUN

DERNIER NUMERO UTILISE : 4707

MODIFICATION									
FOLIO	047								

SIGNALISATION

AFF :371353.03
 PL : E14264



01 02 03 04 05 06 07 08 09 10 11 12 13 14 15 16 17 18 19 20 21 22 23 24 25

012.1202

012.1202



AFF : 371353.03
PL : E14264

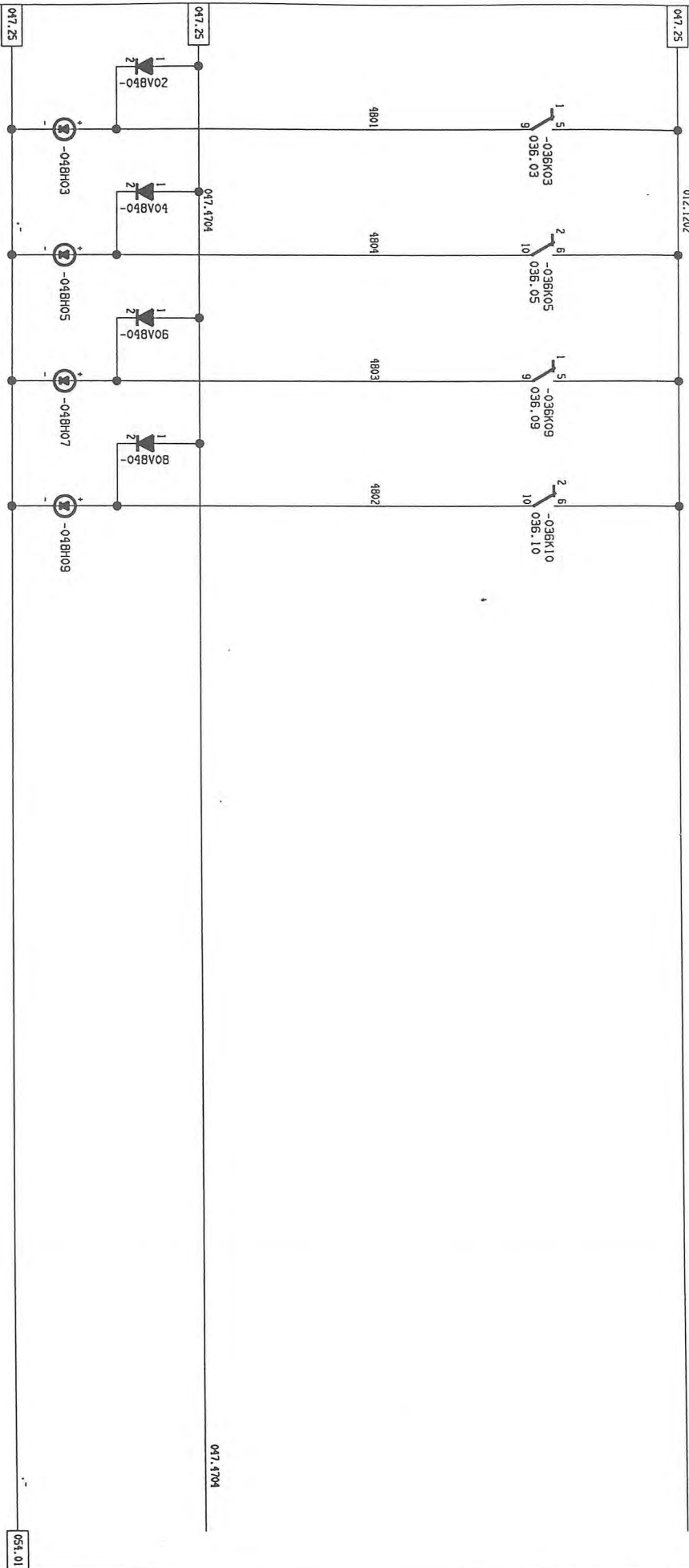

SIGNALISATION

MODIFICATION	

FOLIO
048

DERNIER NUMERO UTILISE : 4804

01 02 03 04 05 06 07 08 09 10 11 12 13 14 15 16 17 18 19 20 21 22 23 24 25

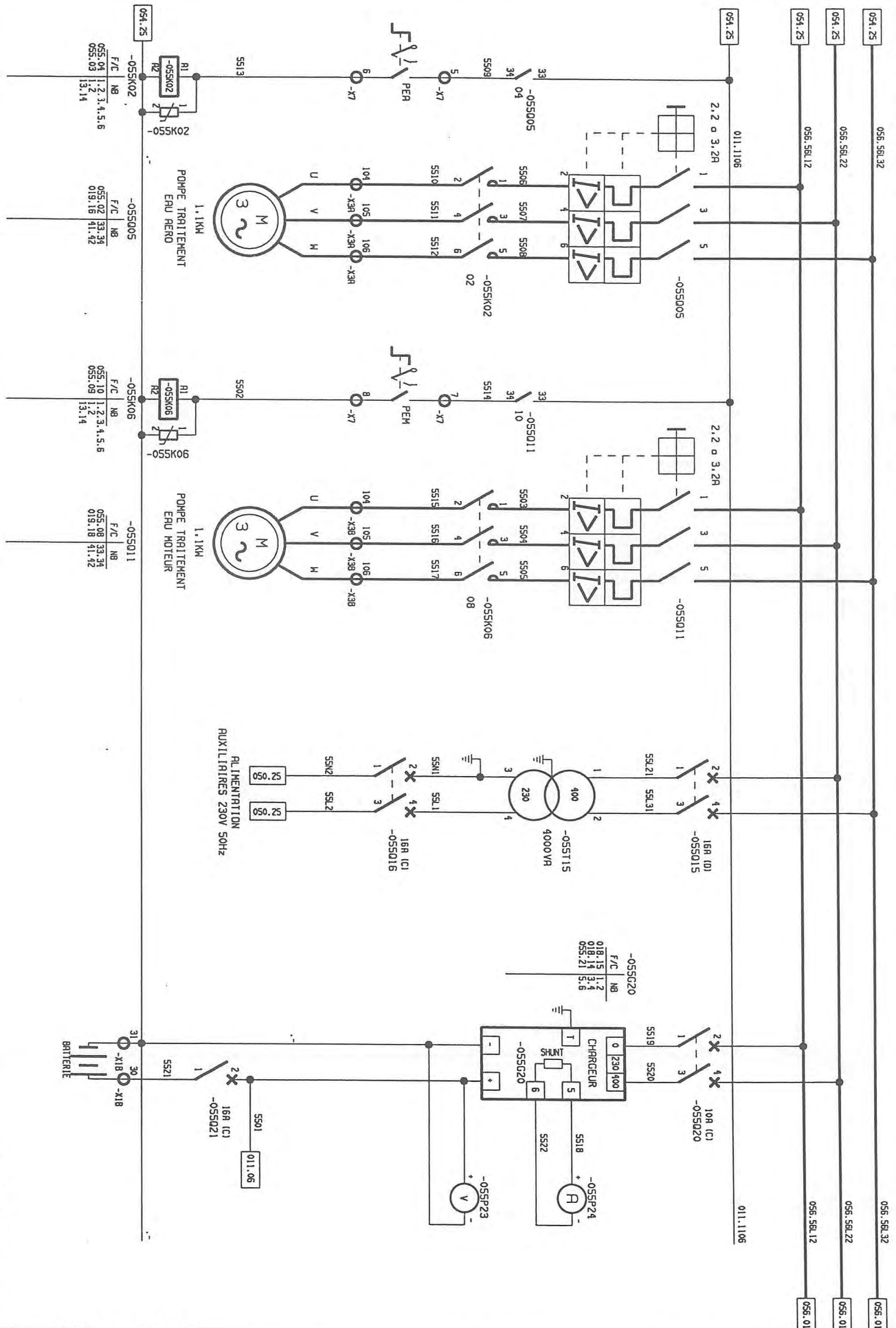

AUXILIAIRES 400V

AFF : 371353.03
PL : E14264



MODIFICATION	

FOLIO 055

DERNIER NUMERO UTILISE : 5522